

Figure 2.2 The J2EE Platform and Technologies

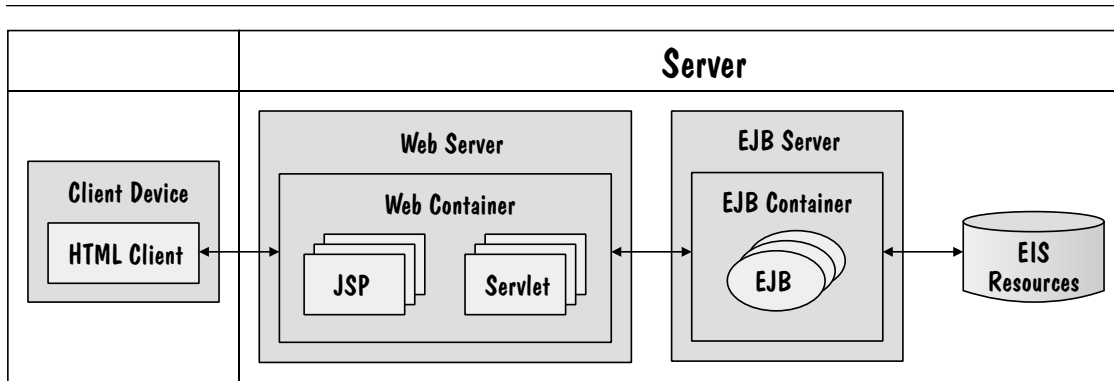
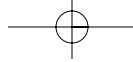
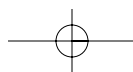
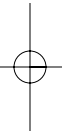
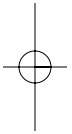

Figure 2.8 Multitier Deployment Configuration



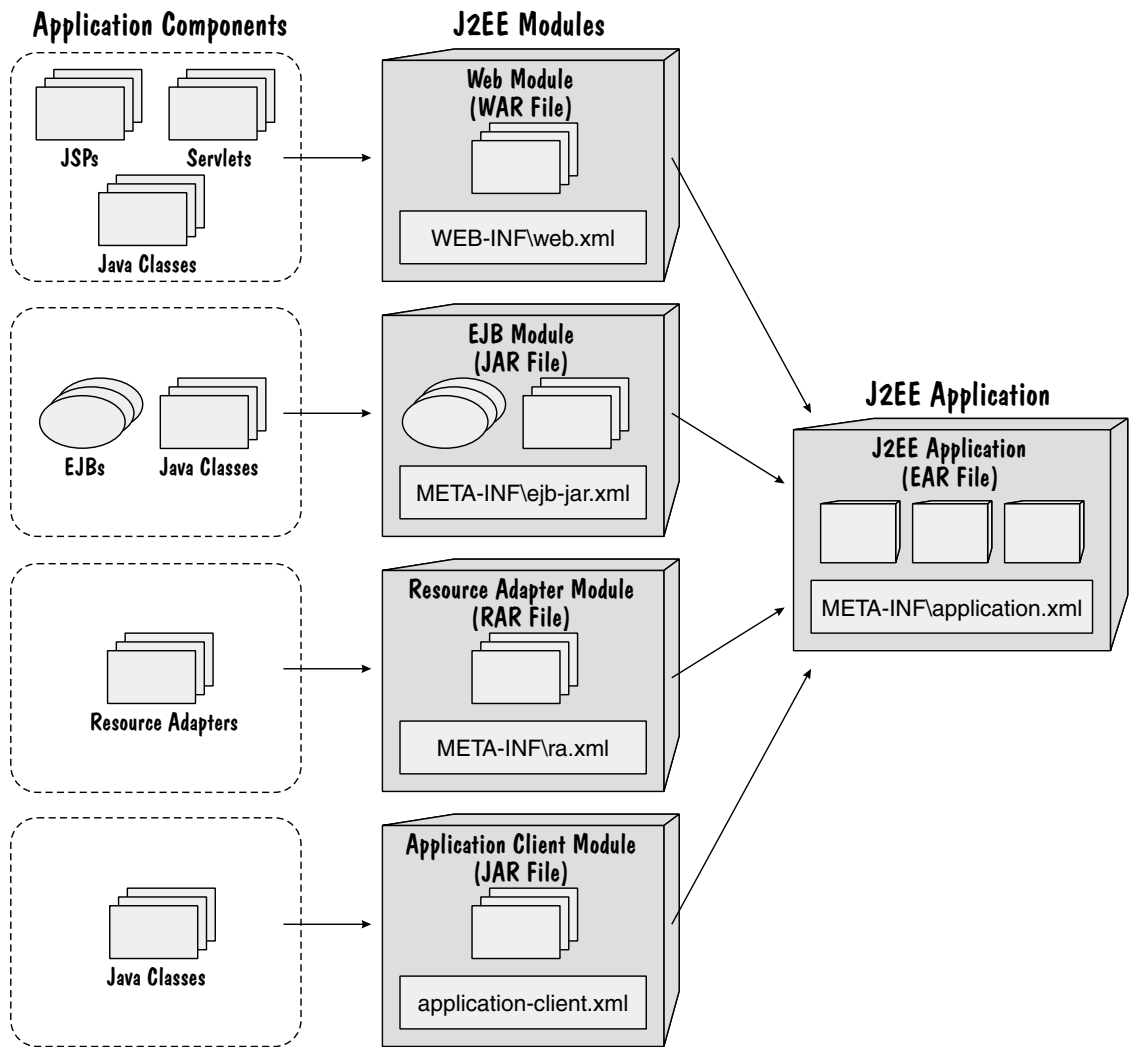

Figure 2.13 J2EE Module Overview

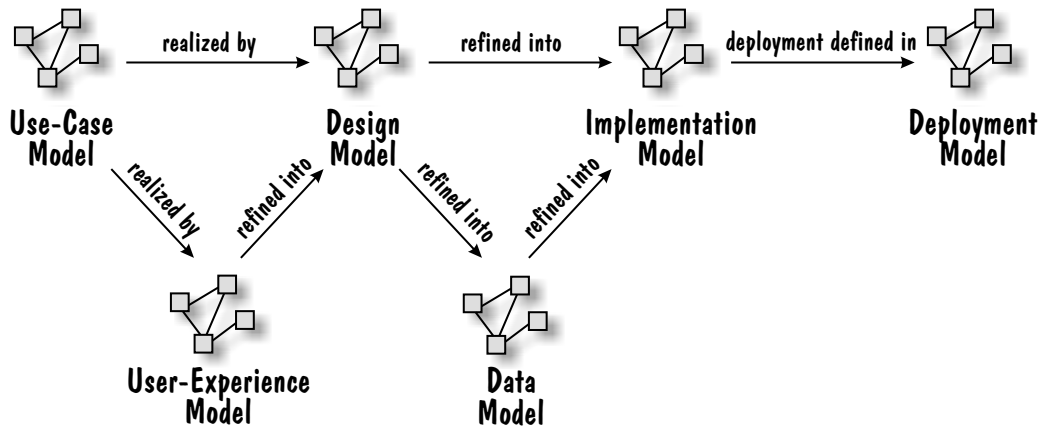
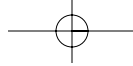
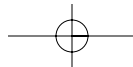
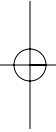
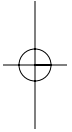

Figure 4.1 J2EE Roadmap System Models



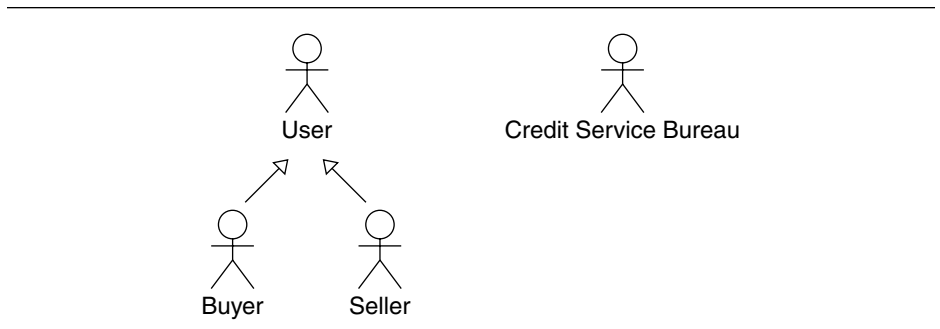
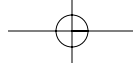
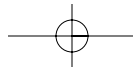
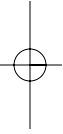
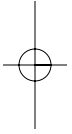

Figure 6.4 Online Auction Application Actors



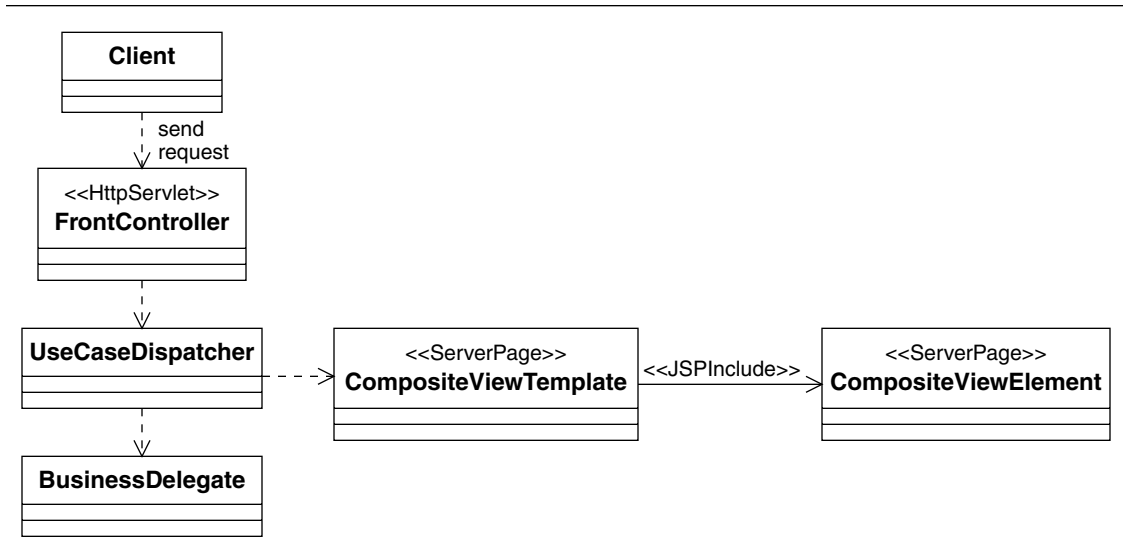
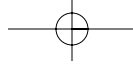
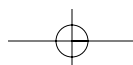
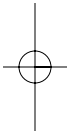
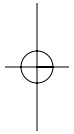

Figure 8.5 The Implementation Strategy for the Presentation Layer



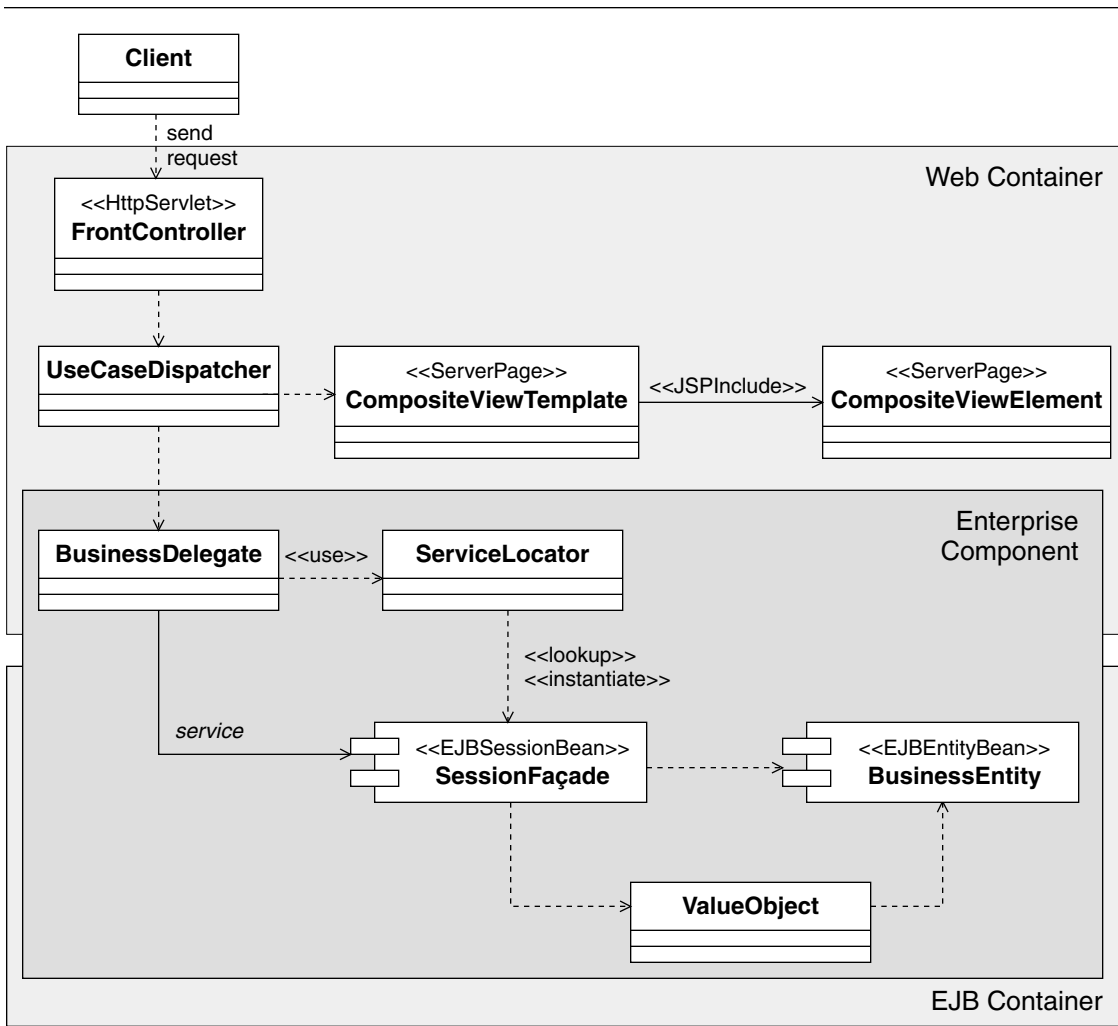

Figure 8.7 An Internal Perspective of an Enterprise Component and Allocation of Its Design Elements to Containers

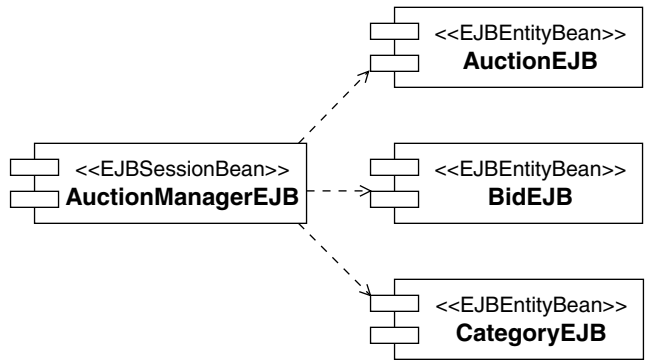
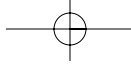
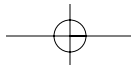
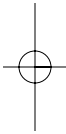

Figure 8.16 Auction Manager EJBs



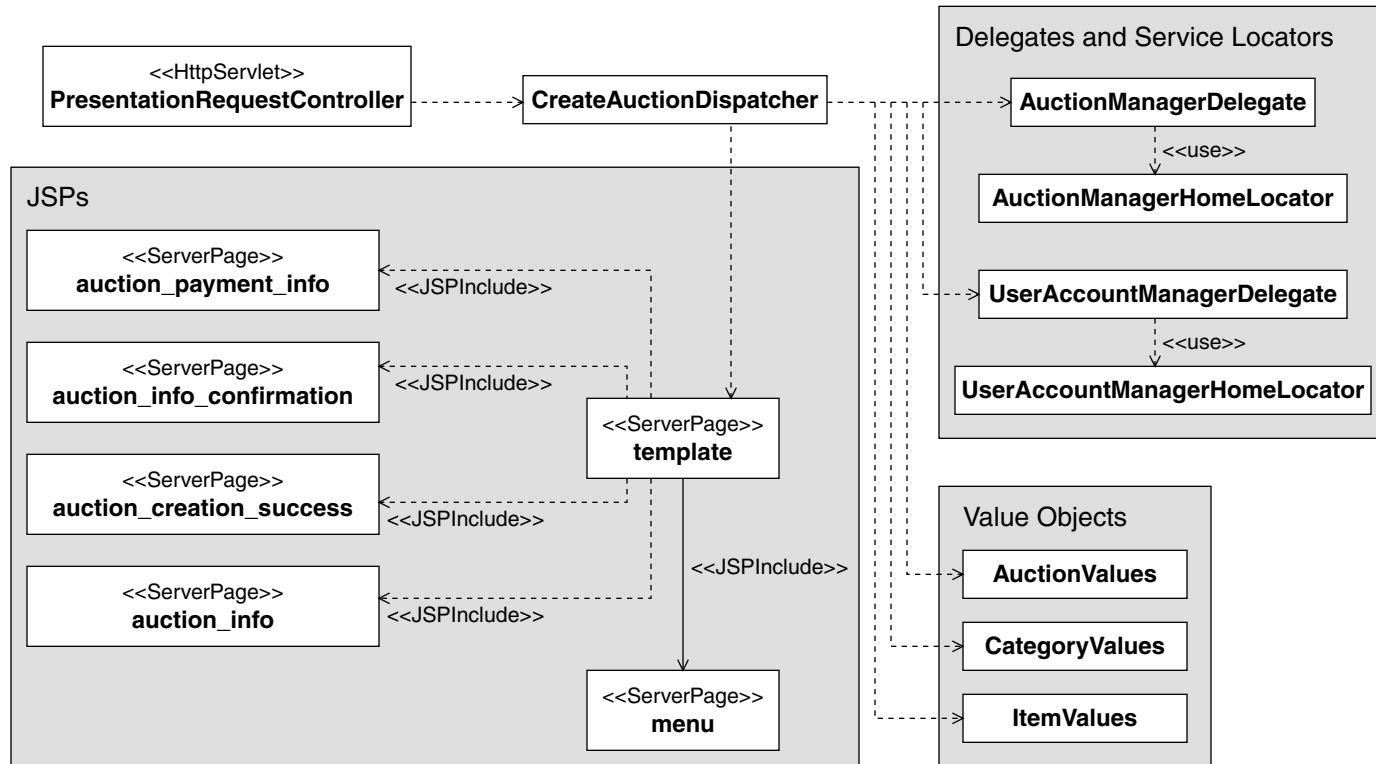

Figure 8.20 Participants in the Create Auction Use Case